

**DIMENSIONS**  
**401-012+CW2030**

**440/450 SERIES**

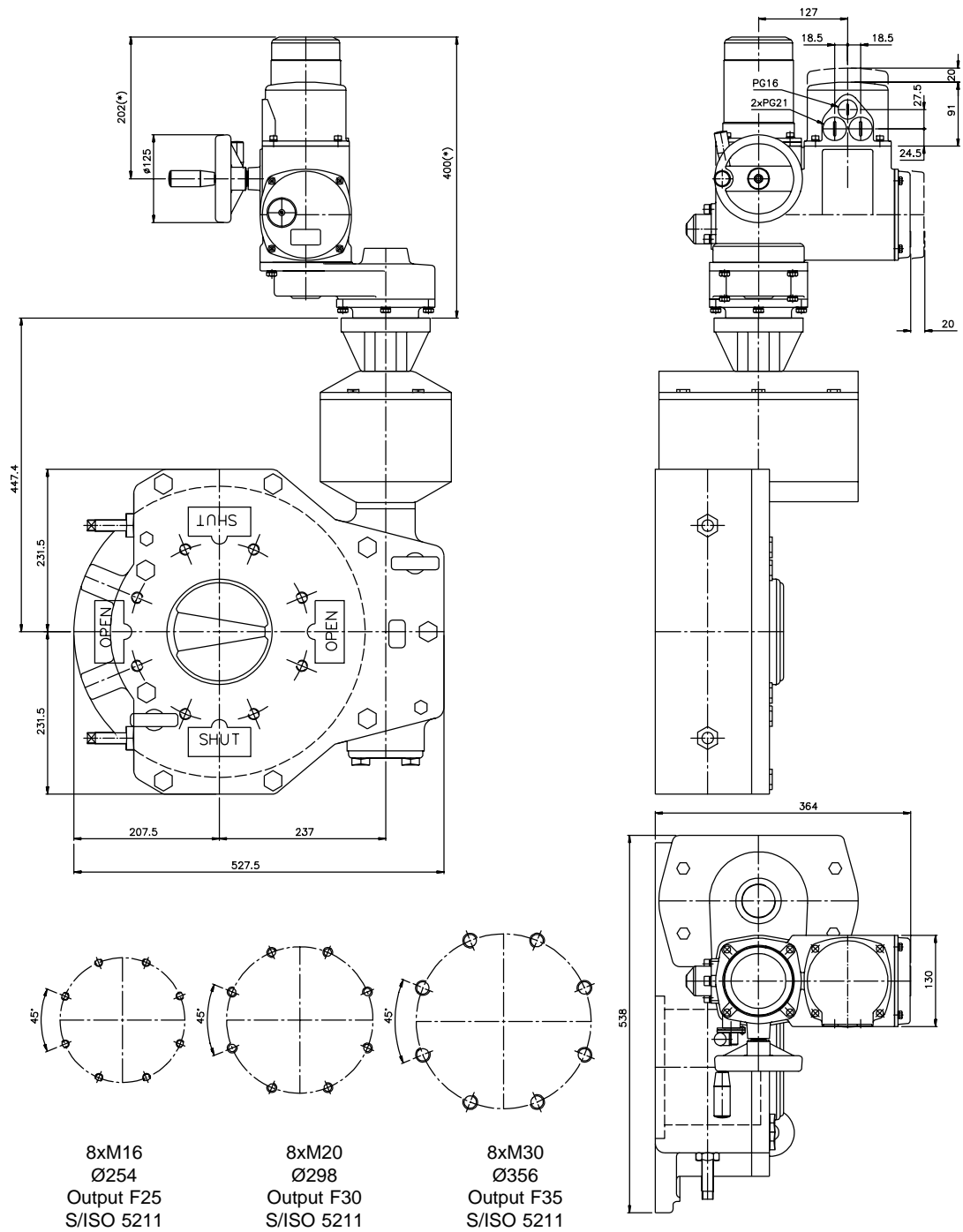

Dimensions in mm.

(\*) Exact dimensions depending on motor required.

**Approximate weight : 205,6 Kg.**

Subject to change without notice. Previous data sheets invalid with the issue of the latest data sheets.

VALVE  
CONTROL



N° :

**E1440X050**

Issued:

**09.99**